



## TENIO

### Fiber Closures

CommScope's fiber optic splice closures are synonymous with excellence in sealing, fiber management, ease of use and design flexibility. Building on almost 30 years of innovation and industry leadership, TENIO closures enable 30-percent faster, future-proof network deployments in 30-percent less space.

TENIO closures feature modular building blocks and combine proven fiber management hardware with a new sealing system to simplify training and reduce inventory. The closure's 100-percent mechanical, tool-less and intuitive design facilitates lower-skilled network deployments.

Full modularity of the closure platform supports a phased CAPEX network deployment scheme, reducing up-front CAPEX investment.

CommScope's superior gel-sealing technology guarantees sealing for most commonly available cable types.

Designed for use with various cable constructions (loose buffer tube and microsheath), the closures deploy in any environment (aerial, pedestal, handhole, manhole).

## Advantages

- Reduce total cost of ownership  
Tool-less, intuitive design assures rapid installation and easy on-going maintenance by less technical workforce
- Optimize cash flow and ROI  
Modular closure platform allows phased network deployment, lower initial CAPEX expenditure
- Fiber and cable technology independent

## Building Block 1: TENIO Cable Seal

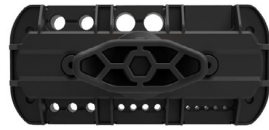

Cable Outs	Diameter Range	Maximum number of In/outlet ports
2a	13-16	12
2b	11-14	
2c	9-12	
3a	7-10	18
3b	5-8	
3 flat	3/5 - 6/9	18
4	3-6	24
5	2-4	30
Dummy		

### Superior sealing performance

- Best available mechanical seal on the market
- 20 kPa and 2 m waterhead compliant with prEN50411-2-10

### Easy Installation

- 60 seconds assembly
- First fully wrap-around, 100% mechanical seal ever introduced into the market
- Installation feedback (Go/No Go trigger activation)
- Tool-less installation

### Flexibility and customization

- Segments are interchangeable
- Field-installable
- Diameter range from 2 - 16 mm

## Building Block 2: TENIO Cable Termination

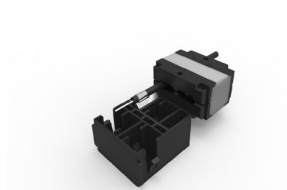
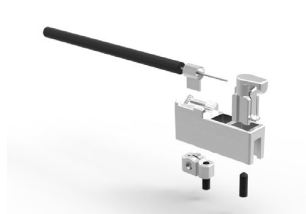
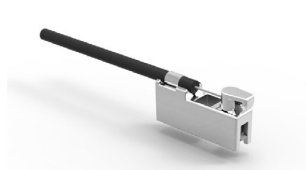

### Superior performance

- Best universal cable termination on the market
- Stronger than T-wraps, safer than hose clamps (no cable damage)

### Easy Installation

- Fully wrap-around
- Only 1 Allen key needed
- Universal housing in closure (black inserts after segmented gel block)

### Cable construction independent

- Diameter range from 2 – 16 mm
- Central/dual strength member and aramid yarn termination

## Building Block 3: Split Dome with Edge Seal



### Faster entry and re-entry

- Just 2 side latches, easily operated manually, achieving a 30% faster entry and re-entry than industry standard today

### Superior quality

- Based on same materials as used for many years in FIST GCO2 and FOSC 400 products

### Universal applicability

- Suited for underground, ground level and aerial use

## Building Block 4: Fiber Management

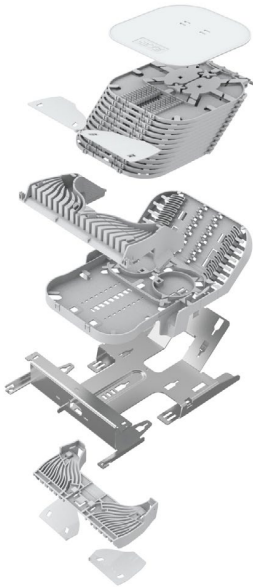

### Reduced installation time

- Optimized FIST fiber management system leading to 30% faster and more intuitive fiber routing and installation
- Up to 144 (12 x 12 fibers), 192 (8 x 24 fibers) or 288 (12 x 24 fibers) fiber splices

### Dedicated storage locations

- Separate location for optical device storage maintains full splice capacity
- Storage basket for looped cable with tubes up to 2.4 mm in diameter
- Integrated basket for drop cable, spare fiber storage

### Fiber and cable technology independent

- Compatible with 652D fiber
- Minimum 1.2 m overlength storage per splice side
- Control fiber/tube grow-out for up to +20 mm

## Sizes

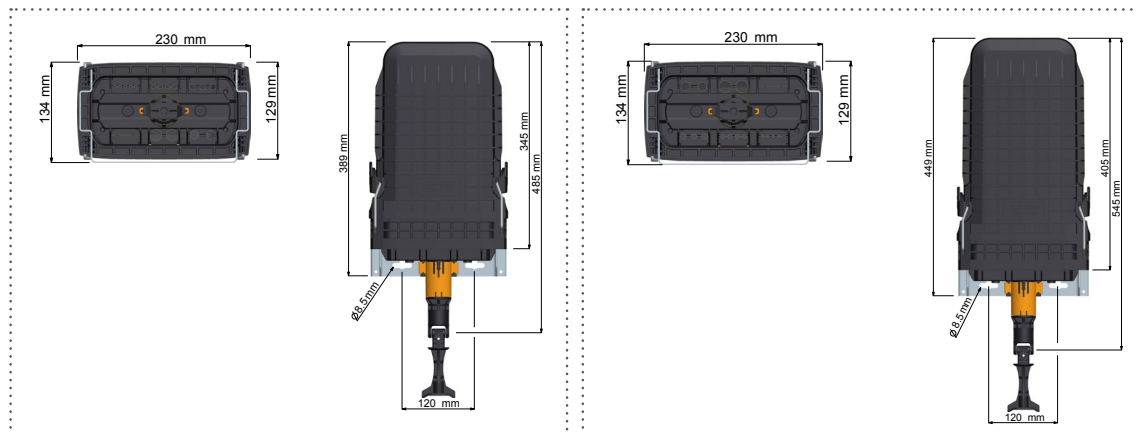

B6 Closure

C6 and C6H closure

## Ordering

To configure a complete TENIO closure, the following items must be specified and ordered as indicated:

### 1. Closure

TENIO closures ship with the number of splice trays requested in the ordering number; order separate splice trays to complete unloaded or partially loaded closures.

### 2. Cable seals

Total number of cable seals per closure MUST equal 6.

### 3. Cable termination units

Order 1 cable termination unit for each cable; looped cables require 2 cable termination units.

## Optional/additional ordering information

- **Accessories**

Mounting bracket: Order 1 mounting bracket per closure

External cable fixation: Order 1 external cable fixation kit per closure

- **Splice trays**

Order separate splice trays to complete unloaded or partially loaded closures.

- **Patch trays**

Order these trays for retrofit in TENIO-B6 or TENIO-C6 closures. These trays provide test/monitoring points.

Adapters are ordered separately; only adapters without flanges fit in these patch trays.

- **Field installable splitter sub-assemblies**

Order this assembly and optical splitter module to add splitting capability to a new or previously installed TENIO closure.

Closure

TENIO-XX-XXX-XX-X

Closure size

B6	Small
C6	Large
C6H	Large, high density

Type of splice tray

NT	No tray
S12	Tray for up to 12 heat shrink splice protectors (SMOUV 45 mm) for B6 size only
A12	Tray for up to 12 ANT splice protectors for B6 size only
S24	Tray for up to 24 heat shrink splice protectors (SMOUV 45 mm) for C6 size only
A24	Tray for up to 24 ANT splice protectors for C6 size only
SLE	Tray for up to 24 heat shrink splice protectors (SMOUV 45mm) for C6H size only

Valve

N	No flash test valve
V	With flash test valve

Number of trays

0	No trays
4, 8, 12	For B6 or C6H sizes
2, 4, 8	For C6 size

TENIO-B6 accommodates up to 12 trays; each tray houses 12 fiber splices for a capacity of 144 fibers.

TENIO-C6 accommodates up to 8 trays; each tray houses 24 fiber splices for a capacity of 192 fibers.

TENIO-C6H accommodates up to 12 trays; each tray houses 24 fiber splices for a capacity of 288 fibers.

The following standard closure configurations have a **minimum order quantity** of 1 piece:

Product Description	Quantity per package	Quantity per pallet	Ordering number
<b>B6 Closures</b>			
No trays, no flash test valve	1	35	TENIO-B6-NT-0-N
No trays, with flash test valve	1	35	TENIO-B6-NT-0-V
12 trays, each for up to 12 heat shrink splice protectors (SMOUV 45 mm), no flash test valve	1	35	TENIO-B6-S12-12-N
12 trays, each for up to 12 heat shrink splice protectors (SMOUV 45 mm), with flash test valve	1	35	TENIO-B6-S12-12-V
<b>C6 Closures</b>			
No trays, no flash test valve	1	24	TENIO-C6-NT-0-N
No trays, with flash test valve	1	24	TENIO-C6-NT-0-V
8 trays, each for up to 24 heat shrink splice protectors (SMOUV 45 mm), no flash test valve	1	24	TENIO-C6-S24-8-N
8 trays, each for up to 24 heat shrink splice protectors (SMOUV 45 mm), with flash test valve	1	24	TENIO-C6-S24-8-V
<b>C6H Closures</b>			
No trays, no flash test valve	1	24	TENIO-C6H-NT-0-N
No trays, with flash test valve	1	24	TENIO-C6H-NT-0-V
12 trays, each for up to 24 heat shrink splice protectors (SMOUV 45mm), no flash test valve	1	24	TENIO-C6H-SLE-12-N
12 trays, each for up to 24 heat shrink splice protectors (SMOUV 45mm), with flash test valve	1	24	TENIO-C6H-SLE-12-V

## Cable Seals

**NOTE:** Total number of cable seals ordered must equal 6 per closure.

Minimum order quantity for seals is 5; minimum order quantity for dummy cable seal is 10.

Product Description		Quantity per package	Quantity per pallet	Ordering number
Number of outlets	Diameter range per outlet			
5	2 mm – 4 mm	5	1280	TENIO-SKG5-2/4(1)
4	3 mm – 6 mm	5	1280	TENIO-SKG4-3/6(1)
3	5 mm – 8 mm	5	1280	TENIO-SKG3-5/8(2)
3	7 mm – 10 mm	5	1280	TENIO-SKG3-7/10(2)
2	9 mm – 12 mm	5	1280	TENIO-SKG2-9/12(2)
2	11 mm – 14 mm	5	1280	TENIO-SKG2-11/14(2)
2	13 mm – 16 mm	5	1280	TENIO-SKG2-13/16(2)
3	Flat cable 3/5 mm x 6/9 mm	5	1280	TENIO-SKG3-3/5x6/9(2)
n.a.	Dummy cable seal	10	2560	TENIO-SKG-DUMMY

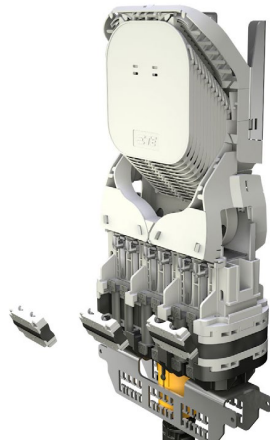

## Cable Termination Units

**NOTE:** Order **1** cable termination unit for each cable; looped cables require 2 cable termination units

Quantity per package/box	Quantity per pallet	Ordering number
20/200	54 boxes/10,800 pieces	TENIO-CTU-S-(20)(1)
10/100	54 boxes/5,400 pieces	TENIO-CTU-L-(10)(2)

(1) TENIO-CTU-S used with cable seals:  
TENIO-SKG5-2/4, TENIO-SKG4-3/6

(2) TENIO-CTU-L used with cable seals:  
TENIO-SKG3-5/8, TENIO-SKG3-7/10, TENIO-SKG2-9/12, TENIO-SKG2-11/14, TENIO-SKG2-13/16, TENIO-SKG3-3/5x6/9

## Mounting Brackets

**NOTE:** Order 1 mounting bracket per closure. Minimum order quantity: 1

Product Description	Quantity per package/box	Quantity per pallet	Ordering number
Mounting bracket	1/10	80	TENIO-MOBRA
External cable fixation bracket	1/10	80	TENIO-EXT/CF

## Splice Trays

**NOTE:** Minimum order quantity: 12 (for small closures) or 8 (for large closures)

### TENIO-XX-TRAY-XXX

#### Closure size

B6	Small (Shipped in pack of 12)
C6	Large (Shipped in pack of 8)
C6H	Large, high density (Shipped in pack of 12)

#### Type of tray

S12	Tray for up to 12 heat shrink splice protectors (SMOUV 45 mm) for B size only
A12	Tray for up to 12 ANT splice protectors for B size only
S24	Tray for up to 24 heat shrink splice protectors (SMOUV 45 mm) for C size only
A24	Tray for up to 24 ANT splice protectors for C size only
SLE	Tray for up to 24 heat shrink splice protectors (SMOUV 45mm) for C6H size only

Product Description	Quantity per package/box	Quantity per pallet	Ordering number
<b>Trays for small closures (B6 size)</b>			
For up to 12 heat shrink splice protectors (SMOUV 45 mm)	12/180	8640	TENIO-B6-TRAY-S12
For up to 12 ANT splice protectors	12/180	8640	TENIO-B6-TRAY-A12
<b>Trays for large closures (C6 size)</b>			
For up to 24 heat shrink splice protectors (SMOUV 45 mm)	8/120	5760	TENIO-C6-TRAY-S24
For up to 24 ANT splice protectors	8/120	5760	TENIO-C6-TRAY-A24
<b>Trays for C6H closures</b>			
For up to 24 heat shrink splice protectors (SMOUV 45mm)	12/120	5760	TENIO-C6H-TRAY-SLE

Patch Trays

TENIO-XX-TRAY-PATCH

Closure size

B6	Small
C6	Large

Patch tray: 3 pieces in a bag

Tray for up to 4 connectors for B6 size only

Tray for up to 8 connectors for C6 and C6H size

Product Description	Quantity per package/box	Quantity per pallet	Ordering number
<b>B6 Closures</b>			
For up to 2 SC duplex or 1 LC quad adapters (adapters ordered separately)	3/60	2880	TENIO-B6-TRAY-PATCH
<b>C6 Closures</b>			
For up to 4 SC duplex or 2 LC quad adapters (adapters ordered separately)	3/60	2880	TENIO-C6-TRAY-PATCH

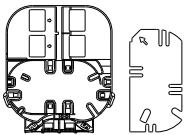

B6 patch tray  
2 SC duplex/  
1 LC quad adapters

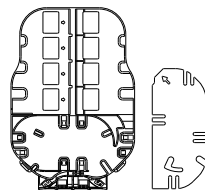

C6 patch tray  
4 SC duplex/  
2 LC quad adapters

These trays are available for retrofit into TENIO-B6 or TENIO-C6 closures. They provide test/monitoring points. A maximum of 3 patch trays can be installed in top positions of tower. Adapters are ordered separately; only adapters without flange can be used in these trays. The capacity for LC and SC connectors is the same due to routing limitations.

Adapters

Product Description	Ordering number
Duplex SC/APC	1966062-5
Duplex SC/UPC	1966062-1
Quad LC/APC	1695790-3
Quad LC/UPC	1695790-1



## Field-installable splitter sub-assemblies

A dedicated storage area is used to house splitter holders in the TENIO closure.

Splitter holders are available in two sizes: small and large. Holders ship with one splitter each. Small and large holders can contain the following splitter configurations:

Small holders	1:2	2:2
	1:8	2:8
	1:16	
Large holders		2:16
	1:32	2:32
	1:64	2:64

The following table shows the number of holders accommodated by TENIO closures.

Closure size	Maximum number of small holders	Maximum number of large holders
TENIO-B6	8	0
	5	1
	2	2
TENIO-C6	15	0
	12	1
	8	2
	5	3
	2	4

## Fused Biconic Taper (FBT) Splitters in Field-Installable Housing

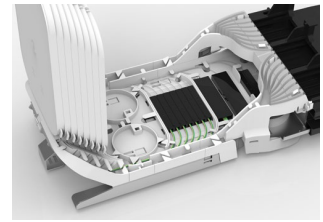

### OCC1A - X X XX - NN ANQNF

#### Number of Incoming Ports

1	1: ...
2	2: ... (50/50 split ratio only)

#### Number of Outgoing Ports

2	... :2
---	--------

#### Split Ratio

00	50/50 symmetrical	25	25/75
05	5/95	30	30/70
10	10/90	35	35/65
15	15/85	40	40/60
20	20/80	45	45/55

#### Housing & Fiber Type

	Housing type	Fiber type	Length (mm)	Width (mm)	Height (mm)	Outer diameter (mm)
ANQNF	F: Field Installable	250 $\mu$ m	55	7.5	6.8	-

Unconnectorized

## PLC Splitters in Field-Installable Housing

### OCC1 X - X XX XX - NN NQNQF

#### Grade

P	Planar
O	Low loss planar

#### Number of Incoming Ports

1	1: ...
2	2: ...

#### Number of Outgoing Ports

04	... :4	32	... :32
08	... :8	64	... :64
16	... :16		

#### Split Ratio

00	symmetrical
----	-------------

#### Housing & Fiber Type

	Housing type	Fiber type
NQNQF	Field Installable	250 $\mu$ m

Unconnectorized





---

[www.commscope.com](http://www.commscope.com)

Visit our website or contact your local CommScope representative for more information.

© 2015 CommScope, Inc. All rights reserved.

TENIO and all trademarks identified by ® or ™ are registered trademarks or trademarks, respectively, of CommScope, Inc.

This document is for planning purposes only and is not intended to modify or supplement any specifications or warranties relating to CommScope products or services.

PS-320107.5-EU (11/15)